

Toradex DSI to HDMI Adapter

Datasheet

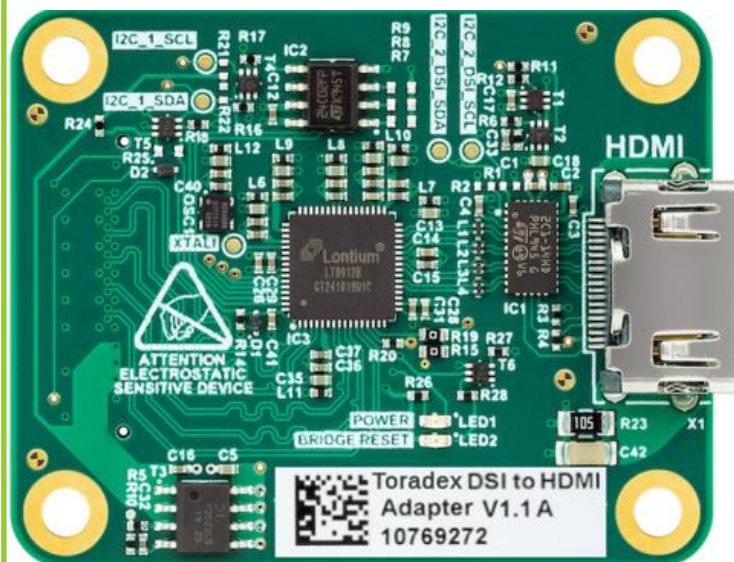

Revision History

Date	Doc. Rev.	Board Version	Changes
20-April-21	Rev. 1.00	V1.1	Initial document release
12-July-21	Rev. 1.01	V1.1	Section 1.1: update reference documents links
28-Nov-24	Rev. 1.02	V1.1	Updated naming from "Verdin DSI to HDMI adapter" to "Toradex DSI to HDMI adapter" Added Aquila Development Board to Reference Documents

Contents

Contents	3
1. Introduction	4
1.1. Reference Documents	4
1.1.1 Toradex DSI to HDMI Adapter Revision History	4
1.1.2 Verdin Development Board Datasheet	4
1.1.3 Dahlia Carrier Board Datasheet	4
1.1.4 Aquila Development Board	4
1.1.5 Toradex Developer Website	4
1.1.6 LT8912B MIPI® DSI to HDMI Bridge Product Brief	4
2. Features	5
2.1. One-Channel MIPI® DSI Receiver	5
2.2. HDMI Transmitter	5
2.3. Hardware Architecture Block Diagram	5
2.4. Physical Drawings	6
2.4.1 Top Side Connector	6
2.4.2 Bottom Side Connector	6
2.4.3 Hardware Setup	7
3. Interface Description	8
3.1. HDMI Connector (X1)	8
3.2. DSI Display Adapter Connector (X2)	9
3.3. LED Indications	11
3.4. Test Points	12
4. Electrical Characteristics	13
4.1. Power Supply Characteristics	13
4.1.1 Supply Voltage	13
4.1.2 Current Consumption	13
5. Operating Conditions	14
5.1. Operating Temperature Range	14
6. Mechanical Data	15
6.1. Toradex DSI to HDMI Adapter Dimensions	15
7. Design Data	17
8. Product Compliance	18

1. Introduction

The Toradex DSI to HDMI Adapter is an add-on board for Toradex's carrier boards which uses a MIPI-DSI interface to provide an HDMI output.

The Toradex DSI to HDMI Adapter uses a Lontium Semiconductor LT8912B MIPI® DSI to HDMI bridge. It features a single-channel MIPI® D-PHY receiver front-end configuration with 4 data lanes operating at a maximum of 1.5Gbps per data lane and a maximum input bandwidth of 6Gbps.

The bridge provides an HDMI 1.4 standard data output with a resolution of up to 60Hz 1080p 8-bit.

The Toradex DSI to HDMI Adapter can be connected to the MIPI® DSI connector of compatible carrier boards.

1.1. Reference Documents

For related technical information and information on compatible products, please refer to the following documents:

1.1.1 Toradex DSI to HDMI Adapter Revision History

<https://developer.toradex.com/hardware/accessories/add-ons/toradex-dsi-display-adapter/>

1.1.2 Verdin Development Board Datasheet

https://docs.toradex.com/109463-verdin_development_board_datasheet_v1.1.pdf

(the Toradex DSI to HDMI Adapter V1.1 is compatible with the Verdin Development Board version starting from V1.1).

1.1.3 Dahlia Carrier Board Datasheet

https://docs.toradex.com/109590-dahlia_datasheet_v1.1.pdf

(the Toradex DSI to HDMI Adapter V1.1 is compatible with the Dahlia Carrier Board version starting from V1.1).

1.1.4 Aquila Development Board

<https://developer.toradex.com/hardware/aquila-som-family/carrier-boards/aquila-development-board>

1.1.5 Toradex Developer Website

<http://developer.toradex.com/>

1.1.6 LT8912B MIPI® DSI to HDMI Bridge Product Brief

http://www.lontiumsemi.com/uploadfiles/pdf/LT8912_Product_Brief.pdf

2. Features

2.1. One-Channel MIPI® DSI Receiver

- Compliant with D-PHY 1.1 and DSI 1.02
- One clock lane and 1~4 configurable data lanes
- From 80Mbps up to 1.5Gbps per data lane
- Data lane swappable and polarity swappable
- Internal Rterm calibration within less than 5% error
- 2-bit programmable equalization
- Only Non-Burst mode supported

2.2. HDMI Transmitter

- Support HDMI 1.4 standard
- Up to 60Hz 1080p 8-bit HDMI output
- 7-bit automatic or manual output swing calibration
- 3-bit programmable de-emphasis

2.3. Hardware Architecture Block Diagram

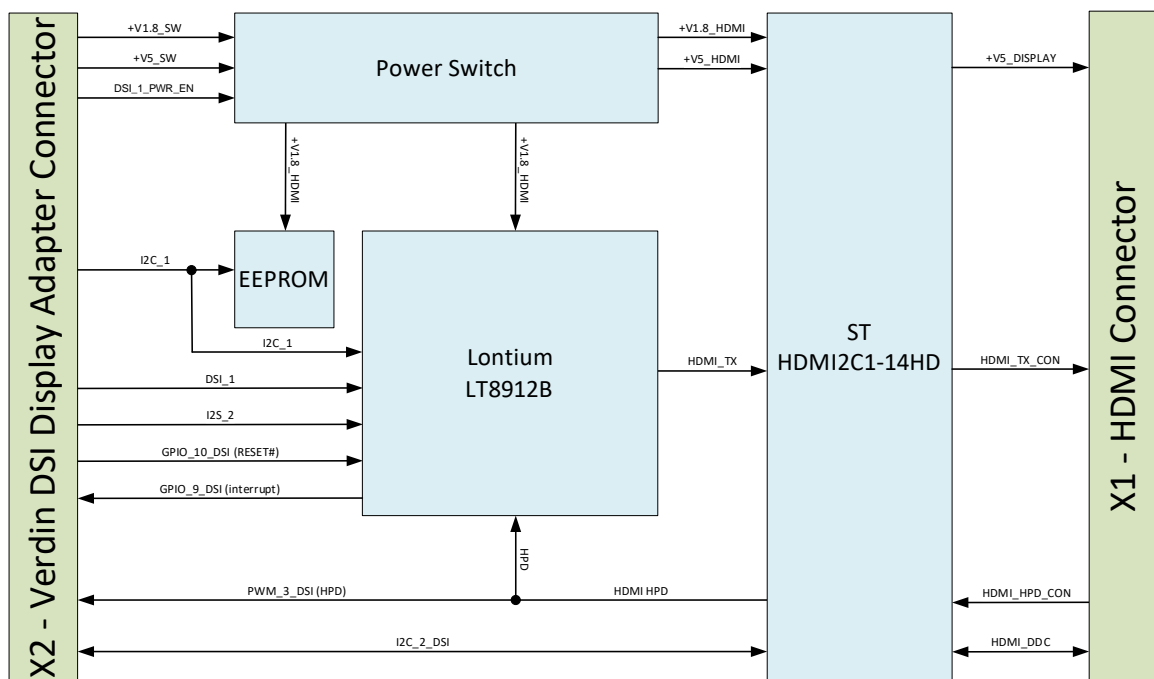

Figure 1. Toradex DSI to HDMI Adapter Hardware Architecture

2.4. Physical Drawings

2.4.1 Top Side Connector

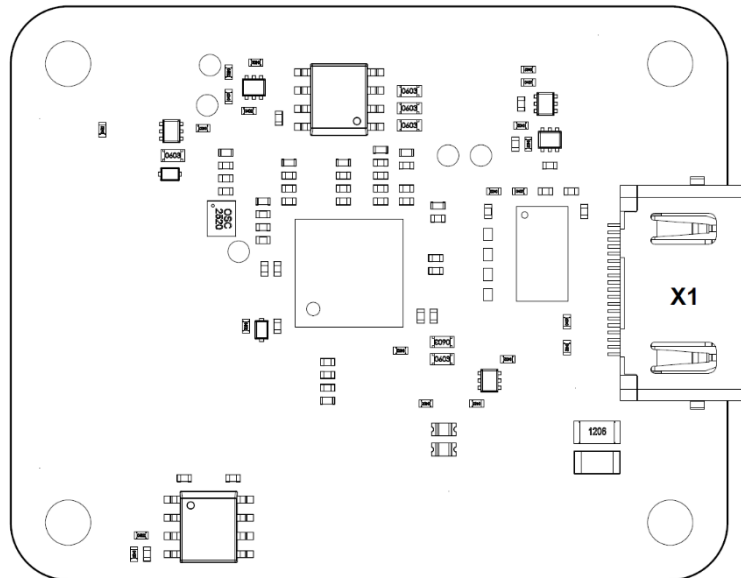

Figure 2. Toradex DSI to HDMI Adapter (top side, top view)

2.4.2 Bottom Side Connector

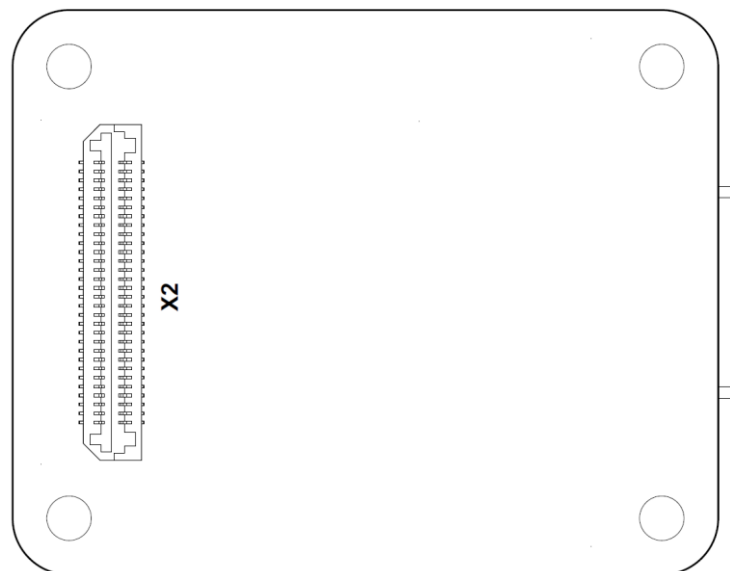

Figure 3. Toradex DSI to HDMI Adapter (bottom side, bottom view)

Ref	Description	Remarks
X1	HDMI Connector	
X2	MIPI® DSI Interface Connector	

2.4.3 Hardware Setup

The Toradex DSI to HDMI Adapter can be attached to the DSI display adapter connector available on supported carrier boards.

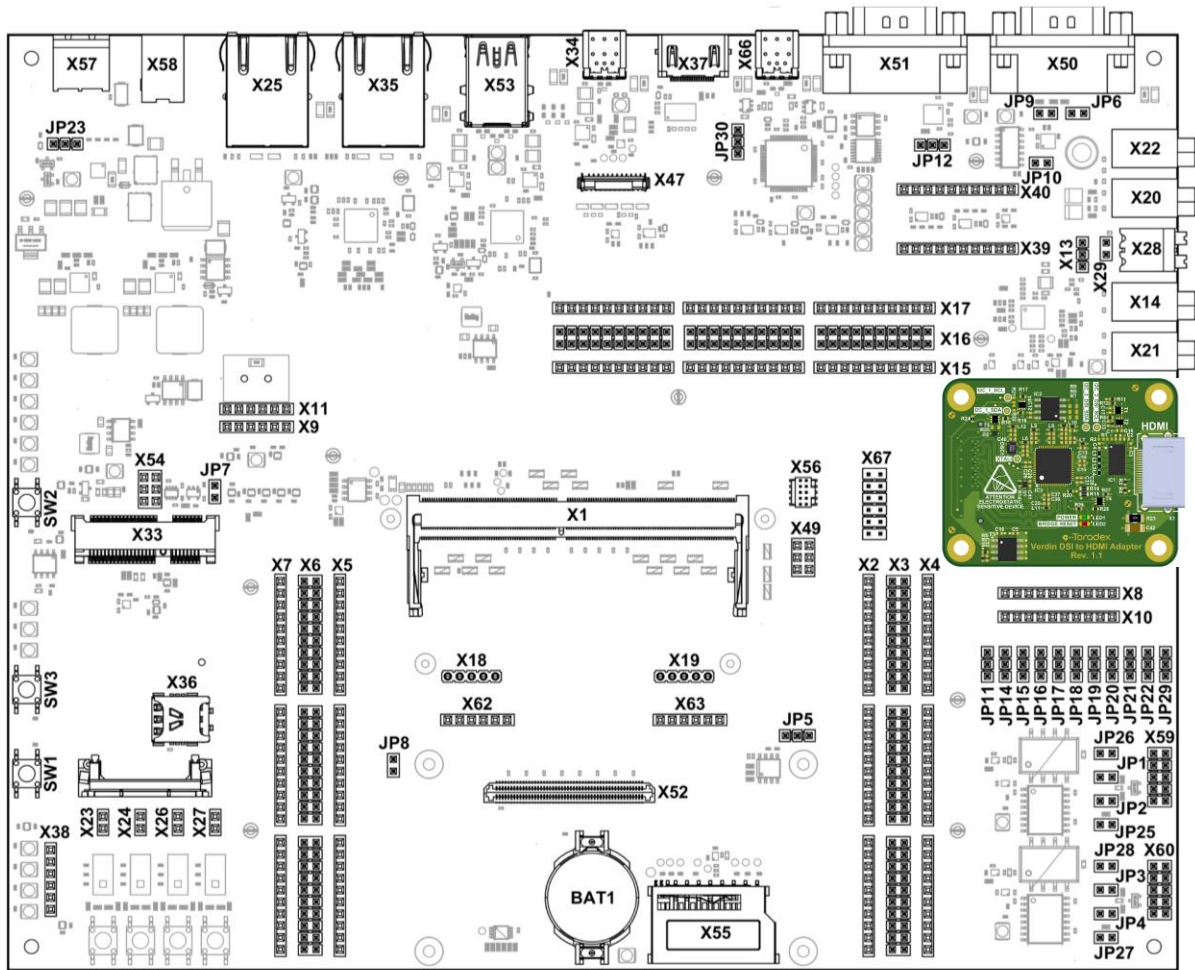

Figure 4. Toradex DSI to HDMI Adapter installed on the Verdin Development Board

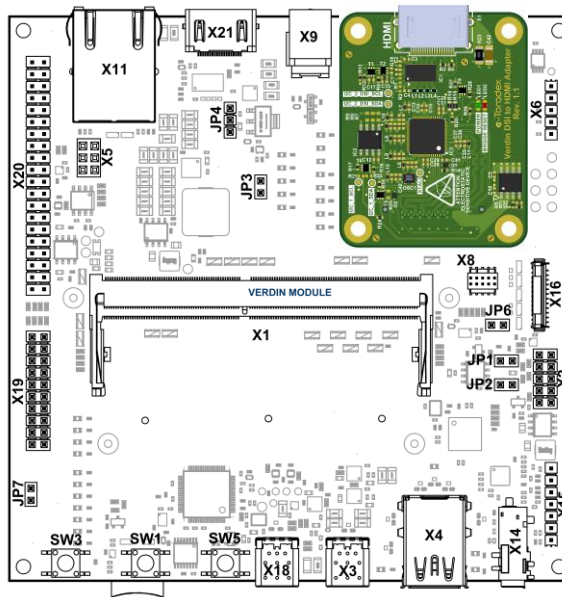

Figure 5. Toradex DSI to HDMI Adapter installed on the Dahlia carrier board

3. Interface Description

3.1. HDMI Connector (X1)

Part Number: Amphenol 10029449-111RLF

Type: HDMI Connector Right Angle

Pin	Signal Name	I/O Type	Voltage	Pull-up/Pull-down	Description
1	HDMI_TXD2_CON_P	O			TMDS Data 2+
2	GND	PWR			
3	HDMI_TXD2_CON_N	O			TMDS Data 2-
4	HDMI_TXD1_CON_P	O			TMDS Data 1+
5	GND	PWR			
6	HDMI_TXD1_CON_N	O			TMDS Data 1-
7	HDMI_TXD0_CON_P	O			TMDS Data 0+
8	GND	PWR			
9	HDMI_TXD0_CON_N	O			TMDS Data 0-
10	HDMI_TXC_CON_P	O			TMDS Clock +
11	GND	PWR			
12	HDMI_TXC_CON_N	O			TMDS Clock -
13	NC				Not connected
14	NC				Not connected
15	HDMI_DDC_SCL	O	+5V	1.8k to +V5_DISPLAY	Display Data Channel Clock
16	HDMI_DDC_SDA	I/O	+5V	1.8k to +V5_DISPLAY	Display Data Channel Data
17	GND	PWR			
18	+V5_DISPLAY	PWR	+5V		+5V Power
19	HDMI_HPD_CON	I	+5V		Hot Plug Detect Signal
S1/S2	GND_CHASSIS				
S3/S4	GND_CHASSIS				

3.2. DSI Display Adapter Connector (X2)

Part Number: Samtec LSS-130-03-L-DV-A-K-TR

Type: Board to board mezzanine connector

Pin	Signal Name	I/O Type	Voltage	Pull-up/Pull-down	Description
1	NC				Not connected
3	GND	PWR			
5	NC				Not connected
7	NC				
9	NC				
11	NC				
13	NC				
15	NC				
17	NC				+5V power supply input
19	+V5_SW	PWR	+5V		
21	+V5_SW	PWR	+5V		
23	+V5_SW	PWR	+5V		
25	+V5_SW	PWR	+5V		
27	+V5_SW	PWR	+5V		
29	NC				Not connected
31	+V3.3_SW	PWR	+3.3V		+3.3V power supply input
33	+V3.3_SW	PWR	+3.3V		
35	+V3.3_SW	PWR	+3.3V		
37	+V3.3_SW	PWR	+3.3V		
39	+V3.3_SW	PWR	+3.3V		
41	NC				Not connected
43	+V1.8_SW	PWR	+1.8V		+1.8V power supply input
45	+V1.8_SW	PWR	+1.8V		
47	+V1.8_SW	PWR	+1.8V		
49	+V1.8_SW	PWR	+1.8V		
51	+V1.8_SW	PWR	+1.8V		
53	NC				Not connected
55	GND	PWR			
57	NC				Not connected
59	DSI_1_PWR_EN	I	+1.8V	100k to GND	Enable HDMI Adapter power supply
2	NC				Not connected
4	I2C_1_SDA	I/O	+1.8V	on a carrier board	I ² C interface, used for HDMI bridge IC configuration and communicating with EEPROM
6	I2C_1_SCL	I	+1.8V	on a carrier board	
8	GPIO_9_DSI	O(OD)	+1.8V	4.7k to +V1.8_SW	Interrupt signal output with an open drain
10	GND	PWR			
12	DSI_1_D0_P	I/O			DSI Interface data lane 0
14	DSI_1_D0_N	I/O			
16	GND	PWR			
18	DSI_1_D1_P	I			DSI Interface data lane 1
20	DSI_1_D1_N	I			
22	GND	PWR			
24	DSI_1_CLK_P	I			DSI Interface clock

Pin	Signal Name	I/O Type	Voltage	Pull-up/Pull-down	Description
26	DSI_1_CLK_N	I			
28	GND	PWR			
30	DSI_1_D2_P	I			DSI Interface data lane 2
32	DSI_1_D2_N	I			
34	GND	PWR			
36	DSI_1_D3_P	I			DSI Interface data lane 3
38	DSI_1_D3_N	I			
40	GND	PWR			
42	I2S_2_BCLK	I	+1.8V		I2S Clock
44	I2S_2_SYNC	I	+1.8V		I2S Word Select
46	I2S_2_D_OUT	I	+1.8V		I2S Serial Data
48	NC				Not connected
50	GND	PWR			
52	NC				Not connected
54	NC				
56	GPIO_10_DSI	I	+1.8V	10k to +V1.8_HDMI	HDMI bridge IC reset input
58	PWM_3_DSI	O	+1.8V		Hot Plug Detect
60	GND	PWR			

3.3. LED Indications

The Toradex DSI to HDMI Adapter contains two LEDs. These LEDs show the state of the power supply and the bridge IC reset state.

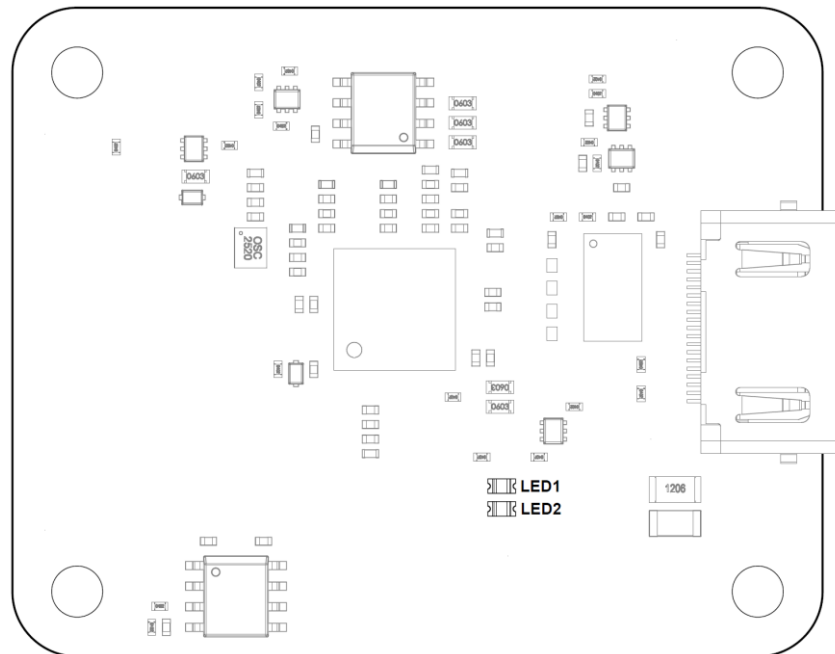

Figure 6. Toradex DSI to HDMI Adapter LEDs

The LEDs and their functions are listed below.

Designator	Silkscreen name	Description
LED1	POWER	LED is lit when adapter board power is enabled
LED2	BRIDGE RESET	LED is lit when the DSI to HDMI bridge IC3 is in the reset state

3.4. Test Points

The Toradex DSI to HDMI adapter features five test points that can be used to measure the related signals.

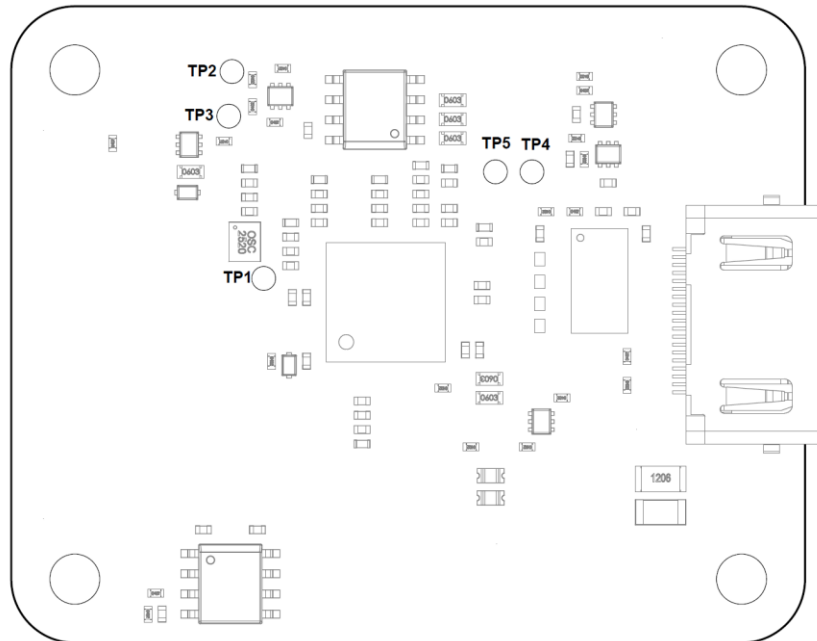

Figure 7. Toradex DSI to HDMI Adapter Test Points

The following tables list the signals available on each test point.

Designator	Net Name	Description
TP1	XTALI	DSI to HDMI Bridge input clock
TP2	I2C_1_SCL	I2C 1 Bus Clock
TP3	I2C_1_SDA	I2C 1 Bus Data
TP4	I2C_2_DSI_SCL	I2C 2 DSI Bus Clock
TP5	I2C_2_DSI_SDA	I2C 2 DSI Bus Data

4. Electrical Characteristics

4.1. Power Supply Characteristics

4.1.1 Supply Voltage

Parameter	Min.	Typ.	Max.	Unit
+V1.8_SW Supply Voltage	1.68	1.8	1.95	V
+V5_SW Supply Voltage	4.9	5	5.3	V

4.1.2 Current Consumption

Parameter	Conditions	Typ. Supply Current	Unit
+V1.8_SW Supply Voltage	HDMI output at 1080p 60Hz	155	mA
+V5_SW Supply Voltage		600	μA

5. Operating Conditions

5.1. Operating Temperature Range

- -40 to +85 °C

6. Mechanical Data

6.1. Toradex DSI to HDMI Adapter Dimensions

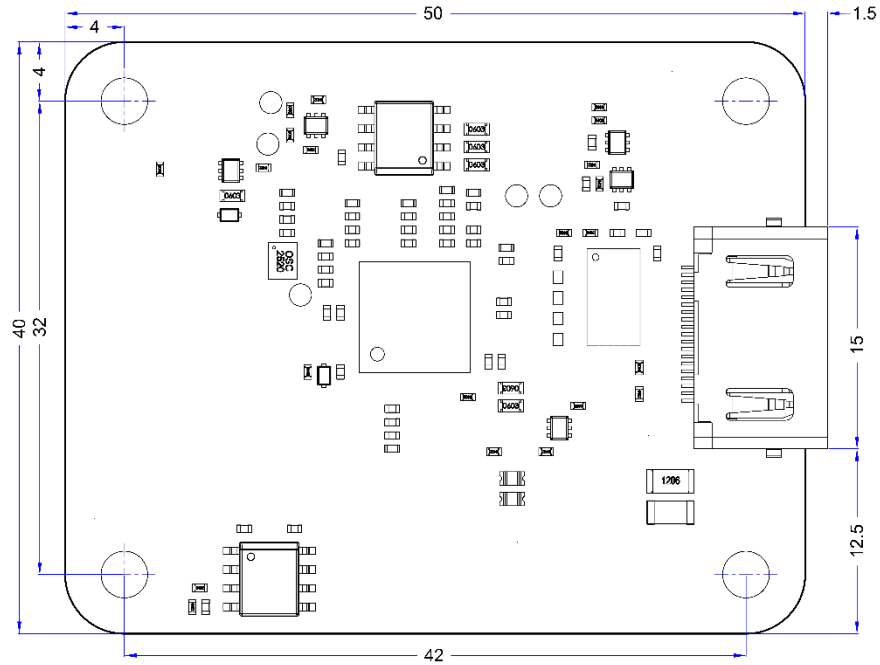

Figure 8. Toradex DSI to HDMI Adapter Dimensions in mm (top side, top view).

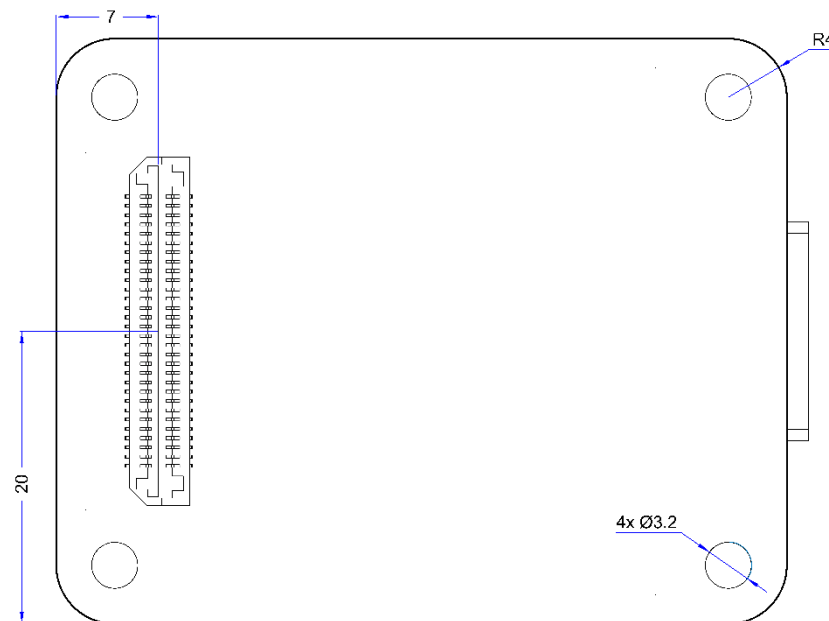

Figure 9. Toradex DSI to HDMI Adapter Dimensions in mm (bottom side, bottom view)

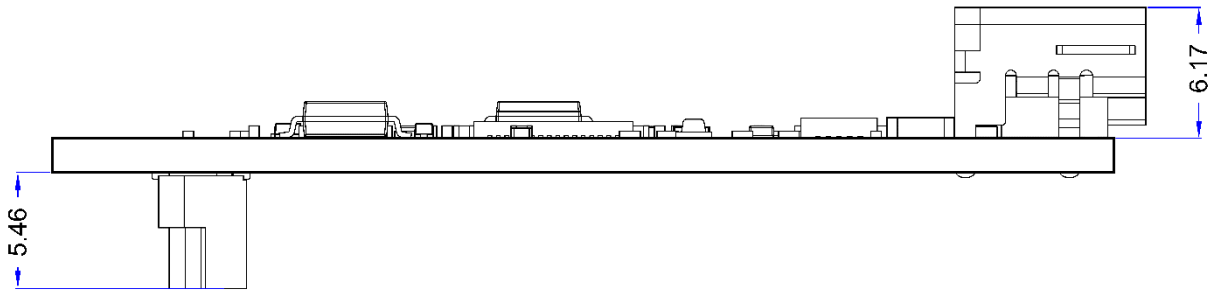

Figure 10. Toradex DSI to HDMI Adapter Dimensions in mm (side1, side 1 view).

7. Design Data

The design data for the Toradex carrier boards and adapter boards are freely available in the Altium Designer format. The design data includes schematics, layout, Bill of Materials (BoM) and component libraries.

To download the board design data, please use the link below:

<https://developer.toradex.com/carrier-board-design/reference-designs>

8. Product Compliance

Up-to-date information about product compliance such as RoHS, CE, UL-94, Conflict Mineral, REACH etc. can be found on our website at: <http://www.toradex.com/support/product-compliance>

DISCLAIMER:

Copyright © Toradex AG. All rights are reserved. The information and content in this document are provided "as-is" with no warranties of any kind and are for informational purposes only. Data and information have been carefully checked and are believed to be accurate; however, no liability or responsibility for any errors, omissions or inaccuracies is assumed.

Brand and product names are trademarks or registered trademarks of their respective owners. Specifications are subject to change without notice.